



# CHATTERTON LACEWORK Pty Ltd

## 2025 RETAIL CATALOGUE

### ACCESSORIES

---





E-mail: [orders@chatterton.com.au](mailto:orders@chatterton.com.au)  
43 Beverage Drive Tullamarine VIC 3043

PH: 03 9330 4466

Website: [www.chatterton.com.au](http://www.chatterton.com.au)

CAT#8/2025

PRODUCT	CODE	AVAILABLE TO FIT	PRICE
<b>Angelina</b> 	B90A	90x90mm (over top of post)	\$52.00
	B901	100x100mm (over top of post)	\$52.00
	B49D	100x100mm	\$52.00
	B48M	120x120mm (over top of post)	\$62.00
	B48A	125x125mm	\$62.00
	B150A	150x150mm (over top of post)	\$80.00
	B50A	150x150mm	\$80.00
	B20A	200x200mm	\$139.00

<b>Burwood</b> 	B590D	90x 90mm (over top of post)	\$52.00
	B5902	100x100mm (over top of post)	\$52.00
	B54D	100x100mm	\$52.00
	B55M	120x120mm	\$62.00
	B55A	125x125mm	\$62.00
	B150B	150x150mm (over top of post)	\$80.00
	B56A	150x150mm	\$80.00
	B20B	200x200mm	\$139.00

<b>Windsor</b> 	B90D	90x90mm (over top of post)	\$50.00
	B903	100x100mm (over top of post)	\$50.00
	B49A	100x100mm	\$50.00
	B48S	120x120mm (over top of post)	\$60.00
	B48D	125x125mm	\$60.00
	B150C	150x150mm (over top of post)	\$80.00
	B50D	150x150mm	\$80.00
	B20C	200x200mm	\$135.00

<b>Fitzroy</b> 	B590A	90x90mm (over top of post)	\$50.00
	B5904	100x100mm (over top of post)	\$50.00
	B54A	100x100mm	\$50.00
	B55S	120x120mm (over top of post)	\$60.00
	B55D	125x125mm	\$60.00
	B150D	150x50mm (over top of post)	\$80.00
	B56D	150x150mm	\$80.00
	B20D	200x200mm	\$135.00

All Products Made From Aluminium

PRODUCT	CODE	AVAILABLE TO FIT	PRICE
<b>Sturt</b> 	B90B	90x90mm (over top of post)	\$50.00
	B5905	100x100mm (over top of post)	\$50.00
	B49B	100x100mm	\$50.00
	B48P	120x120mm (over top of post)	\$60.00
	B48E	125x125mm	\$60.00
	B150E	150x150mm (over top of post)	\$80.00
	B50E	150x150mm	\$80.00
	B20E	200x200mm	\$135.00

## Hawthorn



B590B *	90x90mm (over top of post)	\$50.00
B5906 *	100x100mm (over top of post)	\$50.00
B54B	100x100mm	\$50.00
B55P *	120x120mm (over top of post)	\$60.00
B55C	125x125mm	\$60.00
B150F	150x150mm (over top of post)	\$80.00
B56C	150x150mm	\$80.00
B20F	200x200mm	\$135.00

## Hendon



B90C *	90x90mm (over top of post)	\$52.00
B5907 *	100x100mm (over top of post)	\$52.00
B49C	100x100mm	\$52.00
B48R *	120x120mm (over top of post)	\$62.00
B48B	125x125mm	\$62.00
B150G	150x150mm (over top of post)	\$80.00
B50B	150x150mm	\$80.00
B20G	20x200mm	\$139.00

## Nicolina

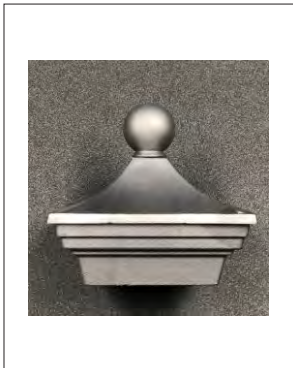

B590C	90 X 90mm (over top of post)	\$52.00
B5908	100x100mm (over top of post)	\$52.00
B54C	100x100mm	\$52.00
B55R	120x120mm (over top of post)	\$62.00
B55B	125x125mm	\$62.00
B150H	150x150mm (over top of post)	\$80.00
B56B	150x150mm	\$80.00
B20H	200x200mm	\$139.00

**All Products Made From Aluminium**

PRODUCT	CODE	AVAILABLE TO FIT	PRICE
<b>Brighton</b> 	B48T	120x120mm (over top of post)	\$69.00
	B48C	125x125mm	\$69.00
	B150I	150x150mm (over top of post)	\$94.00
	B50C	150x150mm	\$94.00
	B20J	200x200mm	\$145.00

<b>Carnegie</b> 	B55T	120x120mm (over top of post)	\$69.00
	B55E	125x125mm	\$69.00
	B150J	150x150mm (over top of post)	\$94.00
	B56E	150x150mm	\$94.00
	B20I	200x200mm	\$145.00

<b>Pyramid</b> 	B30A	90x90mm (over top of post)	\$39.00
	B30B	100x100mm (over top of post)	\$39.00
	B30C	100x100mm	\$39.00
	B30D	120x120mm (over top of post)	\$46.00
	B30E	125x125mm	\$46.00
	B150K	150x150mm (over top of post)	\$72.00
	B30F	150x150mm	\$72.00
	B20K	200x200mm	\$105.00

<b>Hampton</b> 	B31A	90x90mm (over top of post)	\$40.00
	B31B	100x100mm (over top of post)	\$40.00
	B31C	100x100mm	\$40.00
	B31D	120x120mm (over top of post)	\$48.00
	B31E	125x125mm	\$48.00
	B150L	150x150mm (over top of post)	\$75.00
	B31F	150 X 150mm	\$75.00

**Powder Coating Charges Apply on all Post Capitals:**

90 X 90mm CAPITALS	\$9.00 each
100 X 100mm CAPITALS	\$9.00 each
120 x 120MM CAPITALS	\$10.00 each
125 X 125mm CAPITALS	\$10.00 each
150 X 150mm CAPITALS	\$14.00 each
200 X 200mm CAPITALS	\$22.00 each

**All Products Made From Aluminium**

## Post Capital Bases

\* Please be aware there are two types of post capital bases

### Post Capital slides over post

Available in sizes:

90x90mm  
100x100mm  
120x120mm  
150x150mm

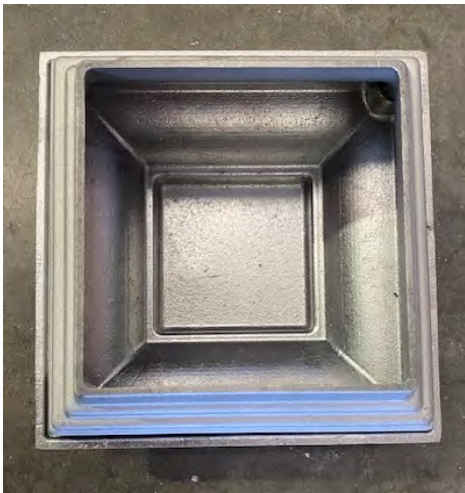

### Post Capital sits on top of the post

Available in sizes:

100x100mm  
125x125mm  
150x150mm  
200x200mm

\* This post capital suits timber posts



Installation is made simple

1. Place over top of post
2. Use screws on either side of capital to secure to post

Installation is made simple

1. Remove the screws from the lid of the casting
2. Drill some screw holes through the bottom casting
3. Put the screws through the bottom holes and screw down tightly into the post

# Designer Post Capital Range

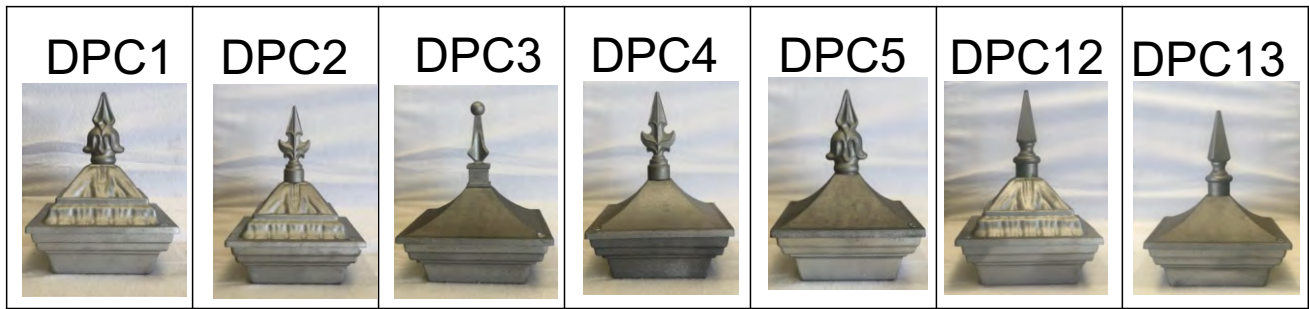

AVAILABLE TO FIT	PRICE
90x90mm (over top of post)	\$56.00
100x100mm (over top of post)	\$56.00
100x100mm	\$56.00
120x120mm (over top of post)	\$60.00
125x125mm	\$60.00
150x150mm (over top of post)	\$88.00
150x150mm	\$88.00
200x200mm	\$139.00

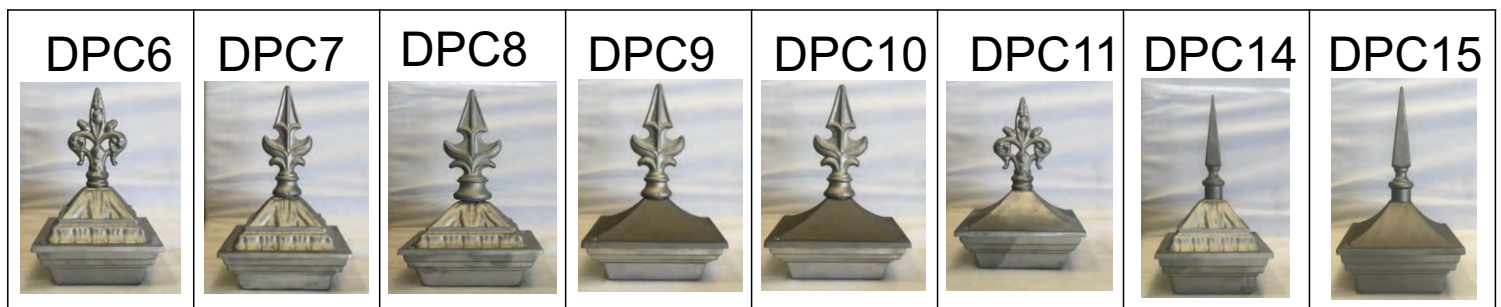

AVAILABLE TO FIT	PRICE
90x90mm (over top of post)	\$58.00
100x100mm (over top of post)	\$58.00
100x100mm	\$58.00
120x120mm (over top of post)	\$62.00
125x125mm	\$62.00
150x150mm (over top of post)	\$90.00
150x150mm	\$90.00
200x200mm	\$139.00

PRODUCT	CODE	SIZE	MILL	P/COATED
---------	------	------	------	----------



LIONPOST	Post & Capital 1555 X 230mm	\$740.00	\$860.00
	Post Only 1070 X 230mm		
	Base 320 X 320mm		



LION POST CAPITAL	230 X 230mm	\$390.00	\$440.00
LION POST SPEAR	320 X 125mm	\$180.00	\$210.00



Twist Post    Intermediate Post

TWIST POST	58 X 58mm Height - 1140mm	\$200.00	\$245.00
	Plain Post		
	With Base Plate	\$250.00	\$295.00
INTERMEDIATE POST	1450 X 55 X 55mm	\$320.00	\$365.00

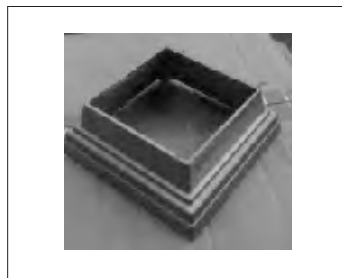





POST BASE	90 X 90mm	\$28.00	\$36.00
POST BASE	100 X 100mm	\$28.00	\$36.00
POST BASE	120 X 120mm	\$32.00	\$40.00





All Products Made From Aluminium





PRODUCT	CODE	AVAILABLE TO FIT	PRICE
<p>Sandcast</p>  <p>B45 B45A B40 B40A</p>	B40	50mm X 1.6 Sq	\$26.00
	B45	50mm X 1.6 Sq	\$38.00
	B40A	65mm X 1.6 Sq	\$28.00
	B45A	65mm X 2.4 Sq	\$41.00
 <p>B46A B52C</p>	B46A	50 X 50mm	\$11.00
	B52C	50 X 50mm	\$11.00
 <p>B46 B52</p>	B46B	60 X 60mm	\$21.00
	B46C	65 X 65mm	\$21.00
	B52D	65 X 65mm	\$21.00
	B46	75 X 75mm	\$24.00
	B52A	75 X 75mm	\$22.00
 <p>CNB30 CNB30R</p>	CNB30	50 X 51mm Ball X 1.6mm Sq	\$11.00
	CNB30R	50 X 51mm Ball X 1.6mm Rnd	\$10.00
	CNB64	50mm X 50mm Ball X 1.6mm Sq	\$10.50
	CNB30A	50mm X 65mm Ball X 1.6mm Sq	\$10.50
	CNB30I	65mm X 65mm Ball X 1.6mm Sq	\$11.50
	CNB30D	75mm X 75mm Ball X 2.4mm Sq	\$13.50
	CNB30H	100mm X 100mm Ball X 2.4mm Sq	\$26.00
	CNB32C	90mm X 100mm Ball X 2mm Sq	\$64.00
	CNB32A	100mm X 100mm Ball X 1.75mm Sq	\$64.00
	CNB32	100mm X 100mm Ball X 3mm Rnd	\$64.00
	CNB32B	100mm X 100mm Ball X 3.75mm Sq	\$64.00



PRODUCT	CODE	AVAILABLE TO FIT	PRICE
 CROWN65L CROWN65  CROWNJ9	CROWN65	65 X 16 X 1.0mm	\$1.70
	CROWN65L	65 X 16 X 1.00mm (lightweight)	\$.95
	CROWNJ9	75 X 16 X 0.9mm	\$1.75
	CROWN75L	75 X 16 X 0.9mm	\$1.20
 MOON CROWNS	MOON	50 X 10 X 0.9mm	\$1.00
	CROWNS	50 X 10 X 0.9mm	\$1.00
 PHALF65 PMOONJ9	HALFMOON65	65 X 16 X 0.9mm (AUSSIE MADE)	\$2.20
	PHALF65	65 X 16 X 0.9mm	\$1.70
	PMOONJ9	75 X 16 X 0.9mm	\$1.95
 POSBE PWINE	POSBE	50 X 10 X 0.9mm	\$1.90
	PWINE	50 X 10 X 0.9mm	\$1.90
 GABLE SCALLOP	GABLE	50 X 10 X 0.9mm	\$1.10
	SCALLOP	50 X 10 X 0.9mm	\$2.00
	SCALLOP1	50 X 10 X 1.2mm	\$2.00
 PTUDJ9 PWINJ9	PTUDJ9	75 X 16 X 0.9mm	\$3.60
	PWINJ9	75 X 16 X 0.9mm	\$3.40
 POSBJ9 VIC 65	POSBJ9	75 X 16 X 0.9mm	\$3.60
	VIC 65	65 X 16 X 0.9mm	\$3.20
 DHP411 SOV65/J9	DHP411	65 X 16 X 0.9mm	\$2.90
	SOV65	65 X 16 X 1.00mm	\$3.70
	SOVJ9	75 X 16 X 0.9mm	\$3.80

PRODUCT	CODE	AVAILABLE TO FIT	PRICE
 <p>165 X 85mm</p>	CA1A	16mm Rnd	\$8.20
	CA1C	19mm Rnd	\$8.20
	CA1V	19.2mm Rnd	\$8.20
	CA1D	20mm Rnd	\$8.20
	CA1T	22.3mm Rnd	\$8.20
 <p>185 X 115mm</p>	CA2A	16mm Rnd	\$9.00
	CA2C	19mm Rnd	\$9.00
	CA2V	19.2mm Rnd	\$9.00
	CA2D	20mm Rnd	\$9.00
	CA2T	22.3mm Rnd	\$9.00
 <p>160 X 85mm</p>	CA3A	16mm Rnd	\$8.37
	CA3C	19mm Rnd	\$8.37
	CA3V	19.2mm Rnd	\$8.37
	CA3D	20mm Rnd	\$8.37
	CA3T	22.3mm Rnd	\$8.37
 <p>160 X 65mm</p>	CA4E	15.9mm Rnd	\$3.50
	CA4A	16mm Rnd	\$3.50
	CA4B	16mm Sq	\$3.50
	CA4C	19mm Rnd	\$3.50
	CA4V	19.2mm Rnd	\$3.50
	CA4D	20mm Rnd	\$3.50
	CA4J	20mm Sq	\$3.50
	CA4L/C	19mm Rnd	\$6.90
 <p>170 X 75mm</p>	CA4L/V	19.2mm Rnd	\$6.90
	CA4L/D	20mm Rnd	\$6.90

PRODUCT	CODE	AVAILABLE TO FIT	PRICE
 100 X 42mm	CA4SV	15.9mm Rnd	\$1.90
	CA4SC	16mm Rnd	\$1.90
	CA4SA	19mm Rnd	\$1.90
 120 X 75mm	CA5E	15.9mm Rnd	\$3.20
	CA5A	16mm Rnd	\$3.20
	CA5B	16mm Sq	\$3.20
	CA5C	19mm Rnd	\$3.20
	CA5V	19.2mm Rnd	\$3.20
	CA5D	20mm Rnd	\$3.20
 85 X 50mm	CA6C	19mm Rnd	\$2.20
	CA6V	19.2mm Rnd	\$2.20
 110 X 30mm	CA7E	15.9mm Rnd	\$1.95
	CA7B	16mm Rnd	\$1.95
	CA7F	19mm Rnd	\$1.95
	CA7G	19mm Sq	\$1.95
	CA7J	20mm Sq	\$1.95
 110 X 30mm	CA7/M3A	19mm X 1.2mm Rnd	\$2.20
	CA7/M26	25mm X 1.6mm Sq	\$2.20

PRODUCT	CODE	AVAILABLE TO FIT	PRICE
 165 X 100mm	CA8E	15.9mm Rnd	\$5.90
	CA8A	16mm Rnd	\$5.90
	CA8C	19mm Rnd	\$5.90
	CA8V	19.2mm Rnd	\$5.90
	CA8D	20mm Rnd	\$5.90
 165 X 95mm	CA9A	16mm Rnd	\$8.15
	CA9C	19mm Rnd	\$8.15
	CA9V	19.2mm Rnd	\$8.15
	CA9D	20mm Rnd	\$8.15
 108 X 35mm	CA11G	15.9mm Rnd	\$2.10
	CA11A	16mm Rnd	\$2.10
	CA11B	16mm Sq	\$2.10
	CA11C	19mm Rnd	\$2.10
	CA11V	19.2mm Rnd	\$2.10
	CA11D	20mm Rnd	\$2.10
 90 X 35mm	CA11/M4	16mm X 1.2mm Rnd	\$2.10
	CA11/M3A	19mm X 1.2mm Rnd	\$2.10
	CA11/M3	19mm X 1.6mm Sq	\$2.20
	CA11/M26	25 mm X 1.6mm Sq	\$2.20
	CA11/M2	20mm X 1.6mm Sq	\$2.20
 140 X 35mm	CA12G	15.9mm Rnd	\$2.30
	CA12A	16mm Rnd	\$2.30
	CA12B	16mm Sq	\$2.30
	CA12C	19mm Rnd	\$2.30
	CA12V	19.2mm Rnd	\$2.30
	CA12D	20mm Rnd	\$2.30
	CA12T	22.3mm Rnd	\$2.30

PRODUCT	CODE	AVAILABLE TO FIT	PRICE
---------	------	------------------	-------



CA12/M4	16mm X 1.2mm Rnd	\$2.50
CA12/M3A	19mm X 1.2mm Rnd	\$2.50
CA12/M2	20mm X 1.6mm Sq	\$2.50
CA12/M26	25mm X 1.6mm Sq	\$2.50



CA13C	19mm Rnd	\$11.00
CA13V	19.2mm Rnd	\$11.00



CA14A	16mm Rnd	\$9.20
CA14C	19mm Rnd	\$9.20
CA14V	19.2mm Rnd	\$9.20
CA14D	20mm Rnd	\$9.20
CA14T	22.3mm Rnd	\$9.20

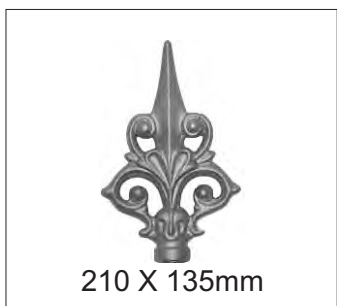

CA15A	16mm Rnd	\$10.50
CA15C	19mm Rnd	\$10.50
CA15V	19.2mm Rnd	\$10.50
CA15D	20mm Rnd	\$10.50
CA15T	22.3mm Rnd	\$10.50



CA16C	19mm Rnd	\$2.20
CA16V	19.2mm Rnd	\$2.20

PRODUCT	CODE	AVAILABLE TO FIT	PRICE
 196 X 45mm	CA17C	19mm Rnd	\$11.00
	CA17V	19.2mm Rnd	\$11.00
 135 X 80mm	CA18E	15.9mm Rnd	\$2.90
	CA18A	16mm Rnd	\$2.90
	CA18C	19mm Rnd	\$2.90
	CA18/M3A	19mm X 1.2mm Rnd Male	\$2.90
	CA18V	19.2mm Rnd	\$2.90
	CA18D	20mm Rnd	\$2.90
 98 X 40mm	CA38C	19mm Rnd	\$2.20
 150 X 70mm	CA39	Flat Base (no hole)	\$9.00
	CA39/M3A	19mm X 1.2mm Rnd	\$9.00
 37 X 32mm	BALLB	16mm Rnd	\$1.90
	BALLC	19mm Rnd	\$1.90
 100 X 27mm	CARDINALA	16mm Rnd	\$1.80
	CARDINALC	19mm Rnd	\$1.80
 95 X 60mm	OZ8	15.9mm Rnd	\$1.80
	OZ2	16mm Rnd	\$1.80
	OZ11	19mm Rnd	\$1.80
	OZ/M3A	80 X 60 X 19 X 1.2mm Rnd	\$1.80

PRODUCT	CODE	AVAILABLE TO FIT	PRICE
---------	------	------------------	-------



CA21A	16mm Rnd	\$3.30
CA21E	16mm Sq	\$3.30
CA21C	19mm Rnd	\$3.30
CA21V	19.2mm Rnd	\$3.30



CA22A	15.9mm Rnd	\$1.80
CA22E	16mm Rnd	\$1.80
CA22C	19mm Rnd	\$1.80



CF5	12.7mm Sq	\$2.10
CF8	15.9mm Rnd	\$2.10
CF1	16mm Sq	\$2.10
CF2	16mm Rnd	\$2.10
CF11	19mm Rnd	\$2.10
CF12	19.2mm Rnd	\$2.10
CF13	20mm Rnd	\$2.10
CF18	22.2mm Rnd	\$2.10



CM4	16mm X 1.2mm Rnd	\$2.10
CM3A	19mm X 1.2mm Rnd	\$2.10

PRODUCT	CODE	SIZE	PRICE
---------	------	------	-------



CB46A	25 X 25mm	\$1.90
CB43A	30 X 30mm	\$1.90
CB32A	32 X 32mm	\$1.90



CB46B	25 X 25mm	\$2.00
CB43B	30 X 30mm	\$2.00
CB32B	32 X 32mm	\$2.00



CB29 Round	31.8mm	\$2.80
CB38 Square	38mm	\$2.20
CB38 Round	38mm	\$2.40



CB44A	38 X 25mm	\$1.60
BR50H	50 X 25mm	\$1.70
CB44R	38 X 25mm	\$1.60



CB38B	38 X 38mm	\$2.20
CB40B	40 X 40mm	\$2.30
CB382	Black 40 X 40mm	\$2.00



CB40A	40 X 40mm	\$1.90
CB40I	40 X 40mm	\$1.90
CB50I	50 X 50mm	\$2.50



PRODUCT	CODE	SIZE	PRICE
---------	------	------	-------



BR25D	25 X 25mm	\$1.40
BR25V	25 X 25mm	\$1.40



Variable Bracket

CB43V	30 X 30mm	\$1.40
Cb383	38 X 38mm	\$2.40



BR38V	38 X 25mm	\$1.80
BR50V	50 X 25mm	\$1.90



Variable Bracket

CB44V	38 X 25mm	\$1.65
-------	-----------	--------



CB41B	40 X 10mm	\$2.20
-------	-----------	--------

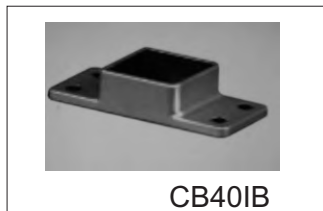

CB40B	40 X 40mm	\$2.40
CB40IB	40 X 40mm	\$2.30
CB40IB Black	40 X 40mm	\$2.40
CB50IB	50 X 50mm	\$2.70



CB50HD	50 X 50mm	\$5.50
--------	-----------	--------

PRODUCT	CODE	SIZE	PRICE
---------	------	------	-------



CB48H	Challenger Bracket	\$2.60
CB50R	50mm Round	\$2.50

### STEEL BRACKETS



GB30A	30 X 30mm Single Lug	\$1.30
GB38A	38 X 25mm Single Lug	\$1.20

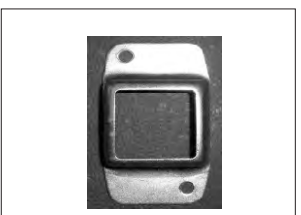

GB32D	30 X 30mm Double Lug	\$1.30
GB38D	38 X 25mm Double Lug	\$1.20
GB40D	40 X 40mm Double Lug	\$1.20



Gb109	40 X 40mm Steel	\$1.40
-------	-----------------	--------



Gb125	40 X 40mm Steel	\$1.40
-------	-----------------	--------

PRODUCT	CODE	SIZE	PRICE
---------	------	------	-------

### Aluminum Caps



CP130/1	30 X 30 X 1.6mm	\$0.80
CP138/1	38 X 25 X 1.6mm	\$0.80
CP150/1	50 X 25 X 1.6mm	\$0.90
CP150/3	50 X 25 X 3mm	\$1.00

PRODUCT	CODE	SIZE	PRICE
---------	------	------	-------

### Aluminium Post Joiner



LBJ50	50 X 50 X 1.6mm	\$6.20
-------	-----------------	--------

PRODUCT	CODE	SIZE	PRICE
---------	------	------	-------

### Aluminum Bushes

  <p style="text-align: center;">Square <b>DHP15-01</b> H 52mm W 40mm 12.7mm 0.6kg \$2.90 ea</p>	  <p style="text-align: center;">Square <b>DHP15-02</b> H 52mm W 40mm 16mm 0.6kg \$2.90 ea</p>	  <p style="text-align: center;">Round <b>DHP15-03</b> H 52mm W 40mm 16mm 0.6kg \$2.90 ea</p>
--	--	---

### Galvabond Steel Post Caps



CP40G	40mm	\$1.00
CP50G	50mm	\$1.10
CP65G	65mm	\$1.40
CP75G	75mm	\$1.70
CP90G	90mm	\$2.70
CP100G	100mm	\$2.70

### Aluminum Post Caps



CPAL50	50mm	\$1.70
CPAL65	65mm	\$2.20

PRODUCT	CODE	DESCRIPTION	PRICE
---------	------	-------------	-------

### Plastic Caps



CPL16R	16mm Rnd	\$0.20
CPL19R	19mm Rnd	\$0.22



CPL25	25mm Sq	\$0.40
CPL30	30mm Sq	\$0.65
CPL40	40mm Sq	\$0.75
CPL50	50 X 50mm Sq Dome	\$0.85
CPL50F	50mm Sq Flat	\$0.75
CPL65	65 X 65mm Sq Dome	\$0.95
CPL3825	38 X 25mm	\$0.60
CPL5025	50 X 25mm	\$0.70

PRODUCT	CODE	DESCRIPTION	PRICE
---------	------	-------------	-------

### Bolts



DB300	300mm Short 125mm Plate Drop Bolt	\$7.60
DB400	400mm Short 125mm Plate Drop Bolt	\$7.90
DB400L	400mm Long 185mm Drop Bolt Plate	\$8.70
DB600	600mm Short 125mm Plate Drop Bolt	\$10.00



PBF438S	100mm Padbolt Short Shoot Single Eye	\$3.00
PBF612L	150mm Padbolt Long Shoot Double Eye	\$5.50
PBF612S	150mm Padbolt Long Shoot Single Eye	\$5.20

PRODUCT	CODE	DESCRIPTION	PRICE
---------	------	-------------	-------

### Gate Latches



DOWNEETOPPULL	Top Pull Pool Latch	\$84.00
---------------	---------------------	---------



DOWNEESIDEPULL	Side Pull Latch	\$36.00
----------------	-----------------	---------



DOWNEEGATEHANDLE	Gate Handle	\$16.00
------------------	-------------	---------

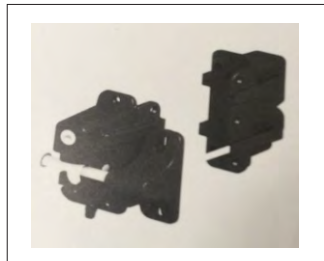

COMBINATIONLATCH	Combination Latch One way	\$64.00
------------------	---------------------------	---------



PRODELUXELATCH	Pro Deluxe Latch Two way	\$73.00
----------------	--------------------------	---------



GRAVITYLATCH	Gravity Latch One way	\$52.00
--------------	-----------------------	---------

### Rising Hinge



DHPRISINGR	Rising Hinge R/H	\$90.00 Pair
DHPRISINGL	Rising Hinge L/H	\$90.00 Pair

PRODUCT	CODE	DESCRIPTION	PRICE
---------	------	-------------	-------



### Hinges

CB75	100 X 75mm Butt Hinge	\$4.50
CB100	100 X 100mm Butt Hinge	\$4.80



DD01	Spring Hinge	\$14.00
DD02	Non-Spring Hinge	\$12.00



DD03	Nylon Adjustable Hinge	\$31.00
------	------------------------	---------

Suitable up to 20kgs



G44L	Weld on Bolt on Hinge L/H	\$16.00
G44R	Weld on Bolt on Hinge R/H	\$16.00

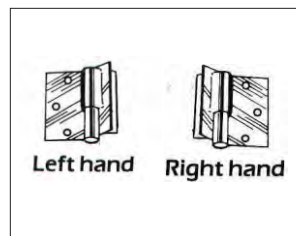

G44BL	Weld on Bolt on Angle Hinge L/H	\$16.00
G44BR	Weld on Bolt on Angle Hinge R/H	\$16.00



G44DL	Weld on Weld on Hinge L/H	\$16.00
G44DR	Weld on Weld on Hinge R/H	\$16.00



G88AL	Bolt on Bolt on Hinge L/H	\$16.00
G88AR	Bolt on Bolt on Hinge R/H	\$16.00



### Heavy Duty Hinge

C141	Weld On Bolt On Heavy Duty Hinge 25mm Brass Washer	\$15.00
------	--	---------

PRODUCT	CODE	DESCRIPTION	PRICE
---------	------	-------------	-------

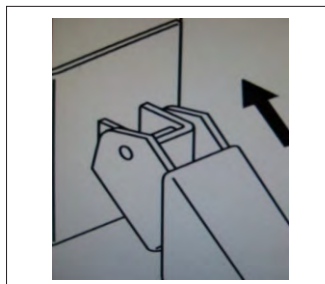

### Steel Zinc Plated Adjustable Brackets

B176R	25 X 25mm Flat Plate	\$6.50
B177R	30 X 30mm Flat Plate	\$6.50
B175R	38 X 25mm Flat Plate	\$6.50
B179R	40 X 40mm Flat Plate	\$6.00

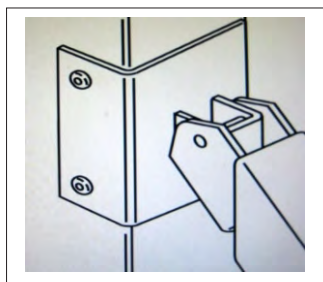

B178R	40 X 40mm Corner Plate	\$7.00
-------	------------------------	--------

PRODUCT	CODE	DESCRIPTION	PRICE
---------	------	-------------	-------

### Aluminium Rings

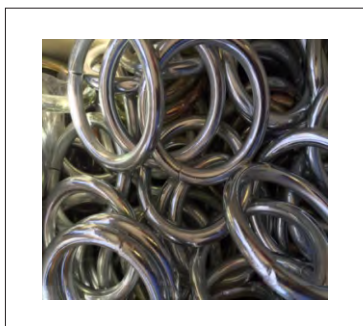

AR/8X73	8 X 73mm Ring	\$1.40
AR/8X78	8 X 78mm Ring	\$1.40
AR/8X82	8 X 82mm Ring	\$1.40
AR/8X90	8 X 90mm Ring	\$1.40
AR/8X100	8 X 100mm Ring	\$1.50
AR/10X82	10 X 82mm Ring	\$1.90
AR/10X90	10 X 90mm Ring	\$2.00
AR/10X100	10 X 100mm Ring	\$2.20

### Steel Rings

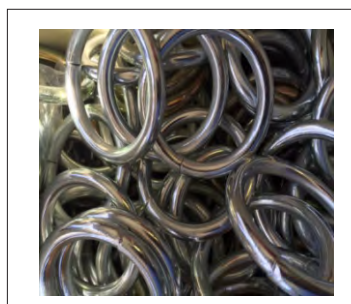

R/8X82	8 X 82mm Ring	\$1.40
R/8X88	8 X 88mm Ring	\$1.40
R/8X100	8 X 100mm Ring	\$1.40
R/10X82	10 X 82mm Ring	\$1.80
R/10X90	10 X 90mm Ring	\$1.80
R/10X100	10 X 100mm Ring	\$2.00

PRODUCT	CODE	DESCRIPTION	PRICE
---------	------	-------------	-------

### Post Feet & Base Cover - Aluminium



BASEC	50 X 50mm Base Cover	\$4.00
PBAFH	50 X 50 X 1.6mm Foot Post	\$10.00
PBAFH65	65 X 65 X 1.6mm Foot Post	\$13.00

### Gate Latch

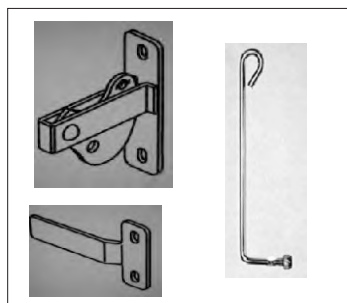

CD23C	Bolt on D Latch & Striker	\$5.00
CD23H	D Latch Handle	\$2.00

PRODUCT	CODE	DESCRIPTION	PRICE
---------	------	-------------	-------

### Steel Brackets

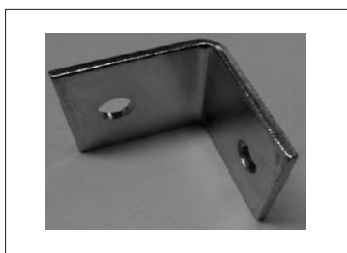

C312	40 X 40 X 40mm	\$1.60
------	----------------	--------



C313	40 X 70 X 70mm	\$1.90
------	----------------	--------



C314	40 X 100 X 40mm	\$1.90
------	-----------------	--------



PRODUCT	CODE	DESCRIPTION	PRICE
---------	------	-------------	-------



### Steel Brackets

C315	40 X 40 x 16mm	\$0.50
------	----------------	--------

PRODUCT	CODE	DESCRIPTION	PRICE
---------	------	-------------	-------

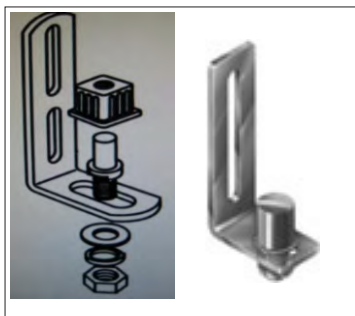

CH309A	38 X 25mm PIN Adjustable	\$15.00
CH309F	38 X 25mm PIN Fixed	\$14.00
CH309B	38 X 25mm Nylon Brush Only	\$3.00

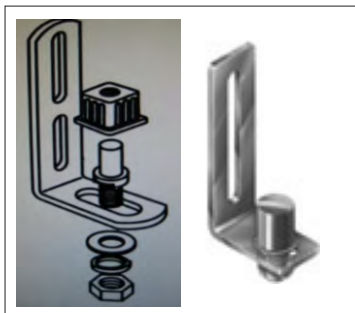

CH310A	25 X 25mm PIN Adjustable	\$15.00
CH310F	25 X 25mm PIN Fixed	\$14.00
DHP310B	25 X 25mm Nylon Brush Only	\$3.00

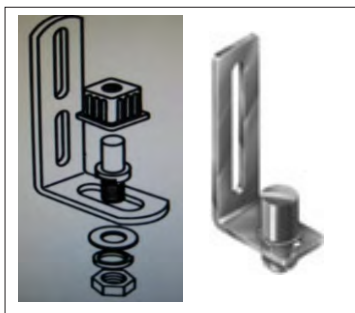

CH311A	30 X 30mm PIN Adjustable	\$15.00
CH311F	30 X 30mm PIN Fixed	\$14.00
CH311B	30 X 30mm Nylon Bush Only	\$3.00

PRODUCT	CODE	DESCRIPTION	PRICE
---------	------	-------------	-------

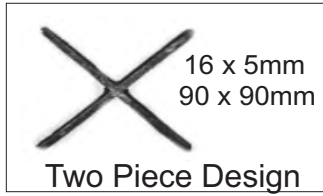

CROSS/A	90 X 90mm Aluminium Cross	\$1.70
CROSS/S	90 X 90mm Steel Cross	\$1.60



DIAMOND	90 X 90mm Steel Diamond	\$1.65
---------	-------------------------	--------

PRODUCT	CODE	DESCRIPTION	PRICE
---------	------	-------------	-------

### Gate Locks



G21PLW	Plain Light Weight	\$15.20
G21TLW	Twist Light Weight	\$15.20
G21PB	Plain Light Weight Brass	\$
G21TB	Twist Light Weight Brass	\$

PRODUCT	CODE	DESCRIPTION	PRICE
---------	------	-------------	-------

### Stainless Steel Gate Locks



SLOCK4	Stainless Steel Gate Lock	\$95.00
--------	---------------------------	---------



SLOCK5	Stainless Steel Gate Lock	\$95.00
--------	---------------------------	---------

PRODUCT	CODE	DESCRIPTION	PRICE
---------	------	-------------	-------



### Paint Range

SC1	COLD GAL	\$13.00
SC2	ALUMINIUM ETCH PRIMER	\$13.00
SC3	POWDERCOAT TOUCH UP	\$10.50
SC4	DY-MARK SILVER BRIGHT	\$13.00

PRODUCT	CODE	DESCRIPTION	PRICE
---------	------	-------------	-------



### Steel Scrolls

DHP300	90 X45mm Mini C Scroll Black	\$1.55
DHP300Z	90 X 45mm Mini C Scroll Zinc	\$2.10



DHP54	220 X 85mm S Scroll Black	\$2.10
DHP54Z	220 X 85mm S Scroll Zinc	\$2.55



### Ball Bearing Hinges

C145	Ball Bearing Hinge 300kg	\$65.00
C144	Ball Bearing Hinge 500kg	\$85.00

PRODUCT	CODE	DESCRIPTION	PRICE
---------	------	-------------	-------

### Aluminium Letterboxes

Parkville Standard box suits picket fence applications  
350 X 185 X 310mm



PARKVILLE	MILL FINISH	\$149.00
PARKVILLE	POWDER COATED	\$169.00

Large box suits brick fence applications  
350 X 185 X 460mm

PARKVILLE	MILL FINISH	\$234.00
PARKVILLE	POWDER COATED	\$259.00

Brunswick Standard box suits picket fence applications  
350 X 185 X 310mm



BRUNSWICK	MILL FINISH	\$159.00
BRUNSWICK	POWDER COATED	\$179.00

Large box suits brick fence applications  
350 X 185 X 460mm

BRUNSWICK	MILL FINISH	\$234.00
BRUNSWICK	POWDER COATED	\$259.00

Royal Park Standard box suits picket fence applications  
350 X 185 X 310mm



ROYAL PARK	MILL FINISH	\$168.00
ROYAL PARK	POWDER COATED	\$188.00

Large box suits brick fence applications  
350 X 185 X 460mm

ROYAL PARK	MILL FINISH	\$248.00
ROYAL PARK	POWDER COATED	\$273.00